

A	B	C	D	A	B	C	D		
1	S462-0015	596	196	2/2	10	S462-3011	855	364	2/2
2	S462-0016	596	396	2/2	11	S462-3012	855	364	2/2
3	S462-1018	1949	399	1/2	12	S462-3013	855	364	2/2
4	S462-1019	1949	399	1/2	13	S462-9011	554	357	2/2
5	S462-1020	394	363	1/2	14	S462-9303	1959	865	1/2
6	S462-1021	370	363	1/2	15	ZK3-5094	544	97	2/2
7	S462-1022	385	363	1/2	16	ZK4-523	350	110	2/2
8	S462-2009	900	400	2/2	17	ZK4-524	350	110	2/2
9	S462-2010	900	400	2/2					

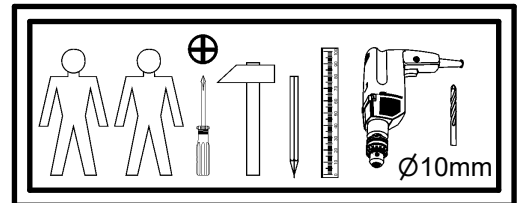

2x  a210	2x  b90	3x  c512	14x  e1 Ø7x50 mm	34x  f1 Ø8x30 mm	4x  f9 Ø6x30 mm	8x  f25 Ø6.5x40 mm	3x  j1 M4x20 mm	1x  k53 Ø50x25 mm
4x  k77 84x40/25 mm	14x  l2	2x  m56/1 80N	2x  m57/1	2x  m57/3	10x  p5 Ø3.5x13 mm	2x  p25 Ø3.5x16 mm	2x  p35 Ø3.5x10 mm	9x  p36 Ø4x25 mm
8x  p38 Ø3.5x16 mm	4x  p51 Ø3.5x15 mm	16x  p55 Ø2.9x16 mm	24x  p140 Ø3.5x12 mm	30x  r1 Ø15x12 mm #16	8x  r15 Ø12x10.5 mm #12	38x  r42 20/11	2x  t35 350 mm	4x  w210/1
4x  w210/2 L-350 mm	18x  s68 Ø 20mm	1x  z1 4 mm					1x  n26	1x  p38 Ø3.5x16 mm

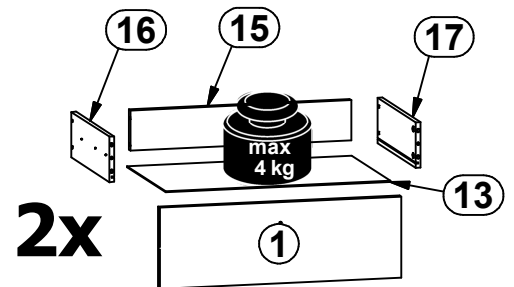

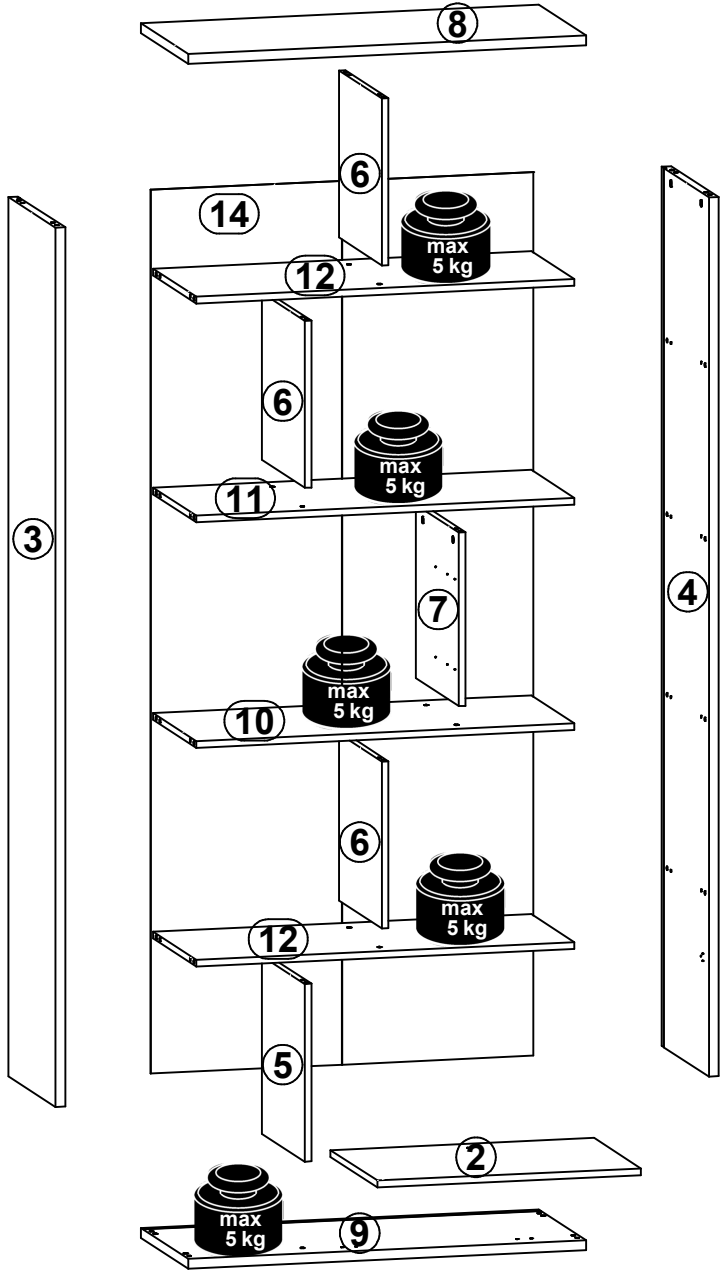
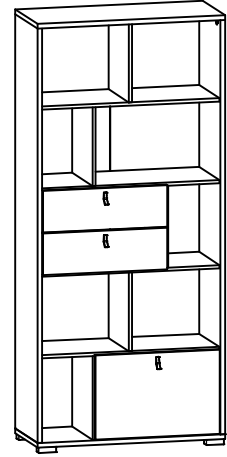

4 §6

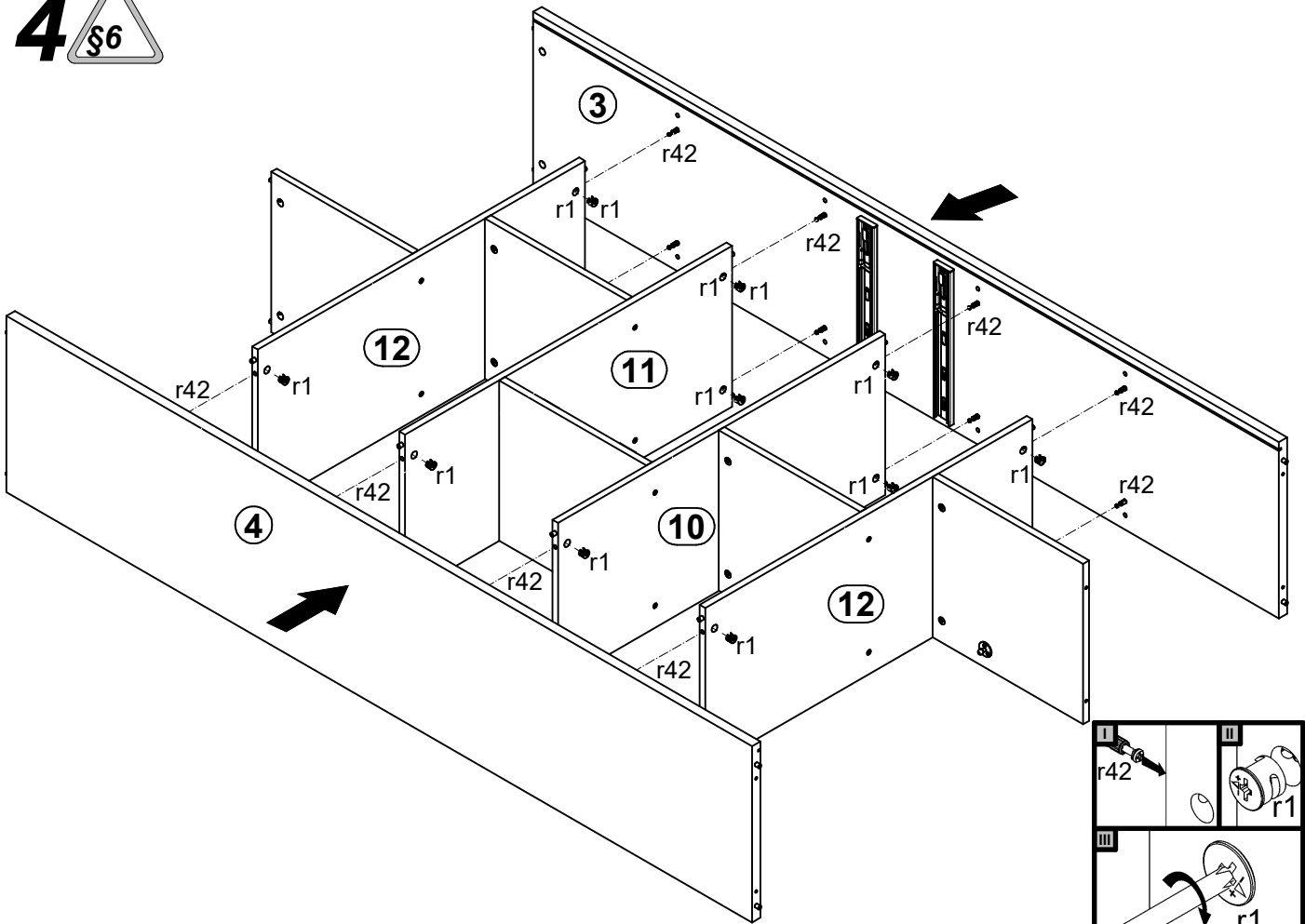

5 §6

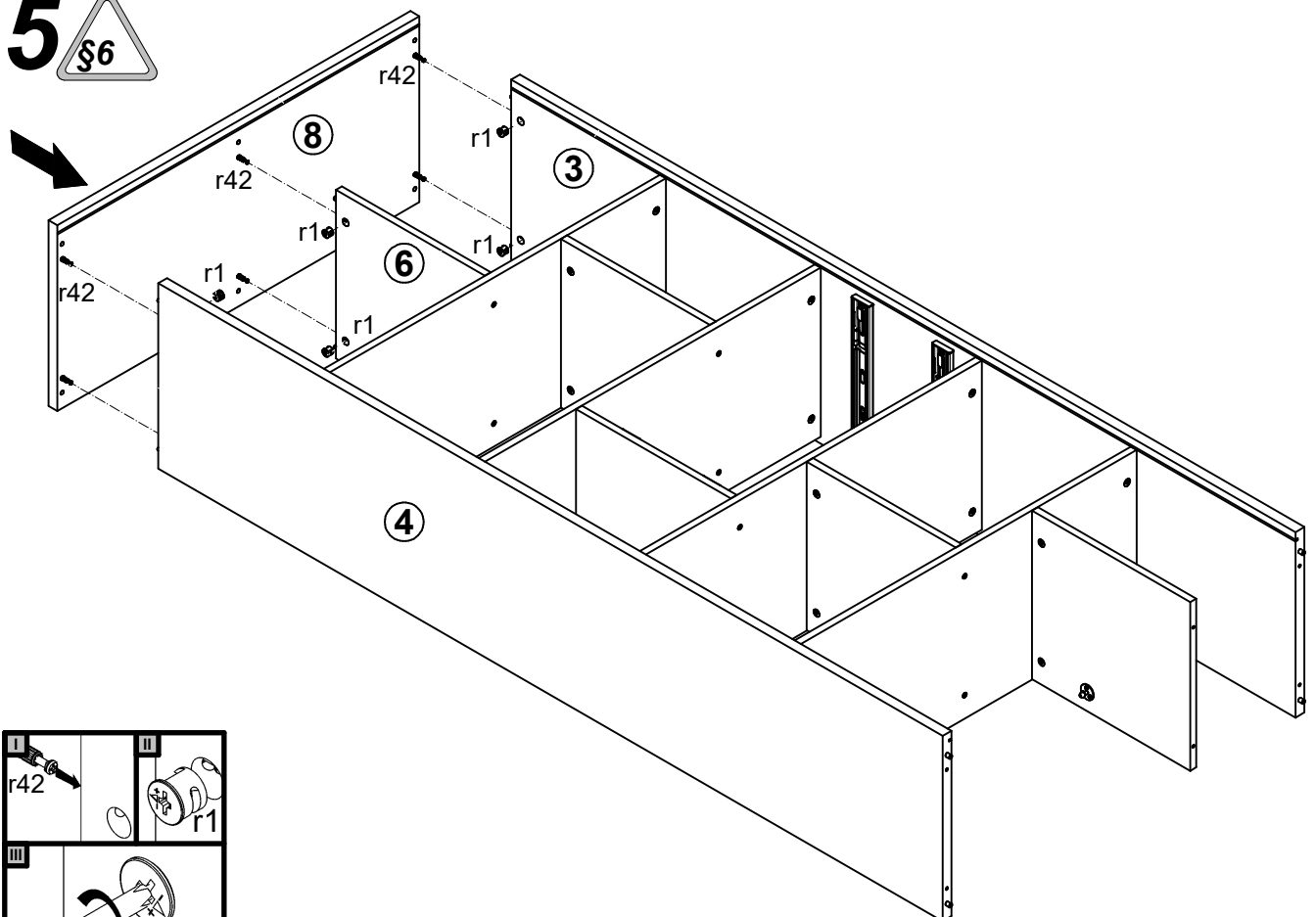

# 6

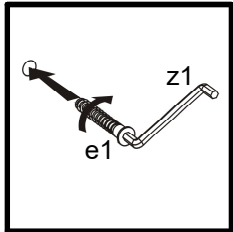
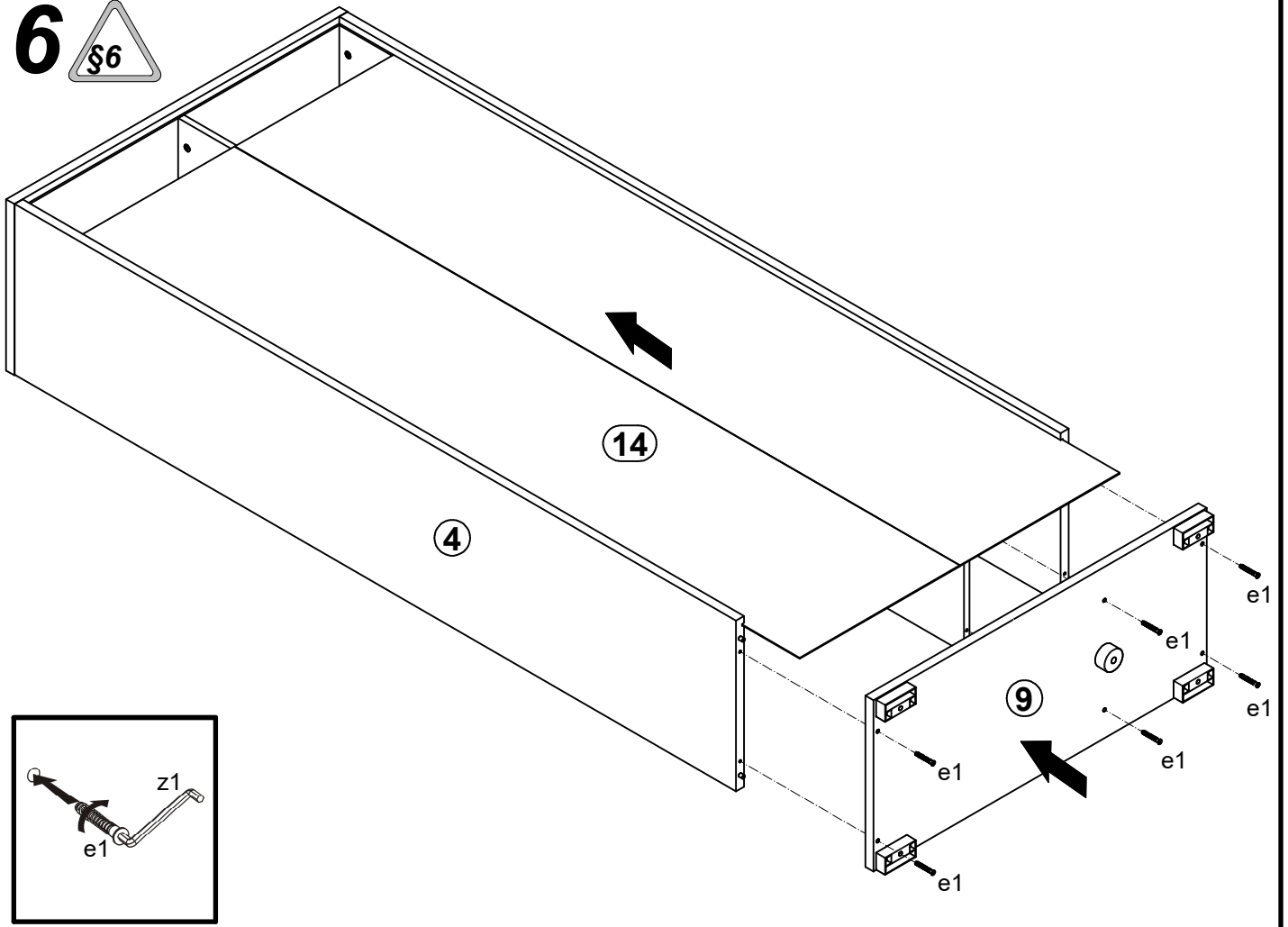

# 7

