

**A**

# LOKSA

**S455-WIE/60**

A	B	C	D
1	S455-0025	1408	590
2	S455-2013	590	300

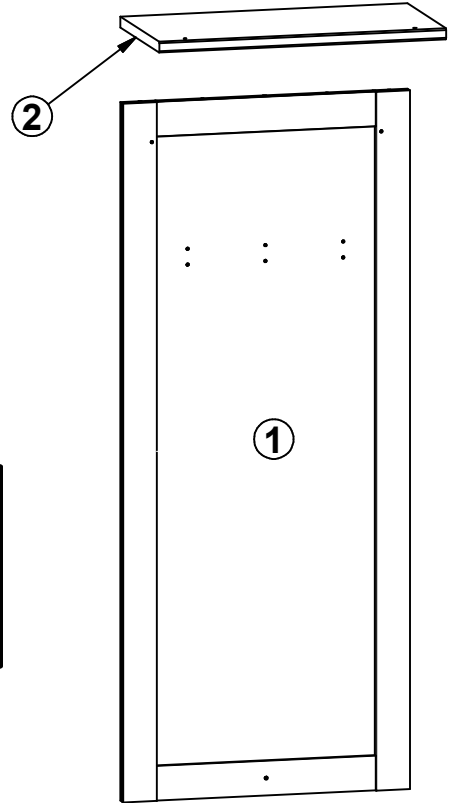
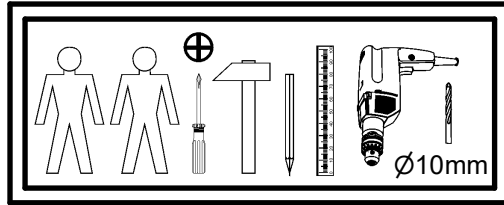
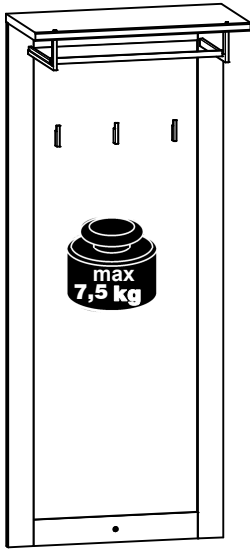

4x Ø5x11 mm <b>e4</b>	4x Ø5x42 mm <b>e44</b>	4x Ø6x30 mm <b>f9</b>	2x <b>g2</b>	3x 32mm <b>g77</b>	1x <b>g78\1L</b>	1x <b>g78\1P</b>	1x <b>g78\2</b>	6x M4x22 mm <b>j60</b>
3x Ø12x10,5 mm #12 <b>r15</b>	3x 20/11 <b>r42</b>			1x Ø6x30 mm <b>f50</b>	1x Ø4x45 mm <b>p62</b>	1x Ø14x0,5 mm <b>s59</b>	2x Ø10x50 mm <b>f35</b>	2x Ø6x60 mm <b>p75</b>

**1** §2

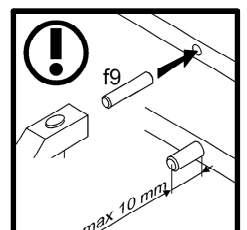
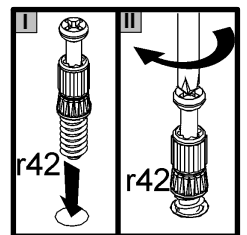
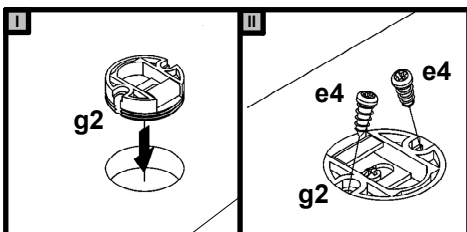
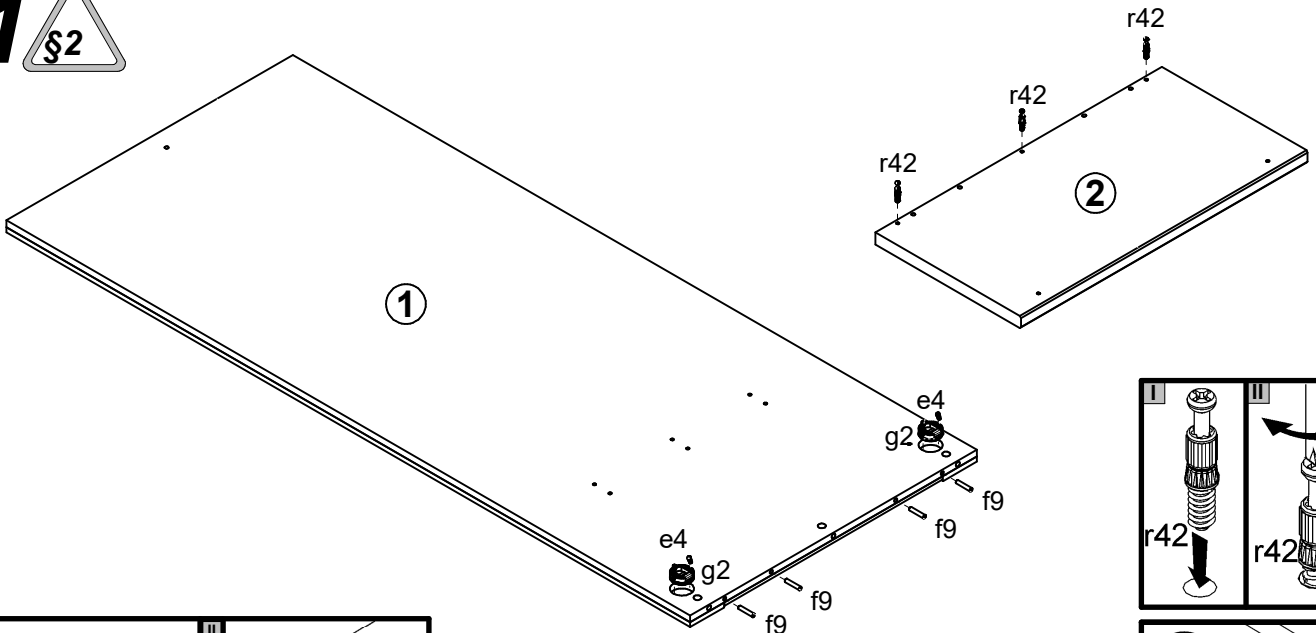

2 §6

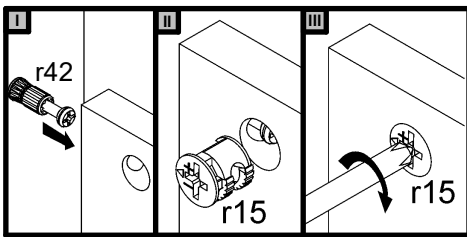
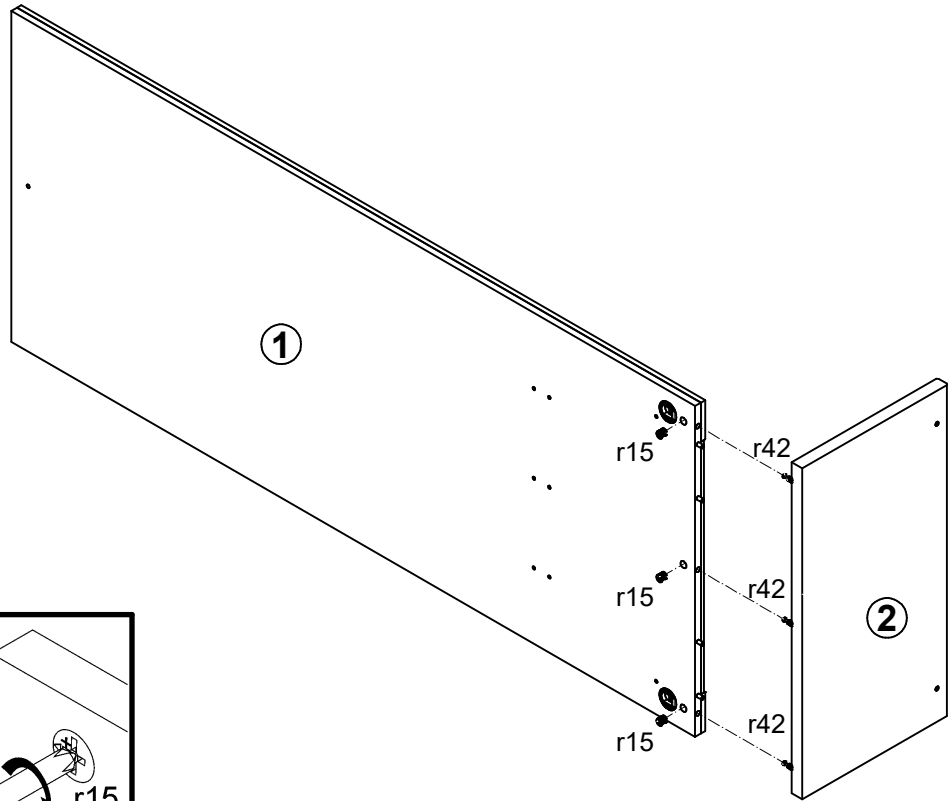

3 §6

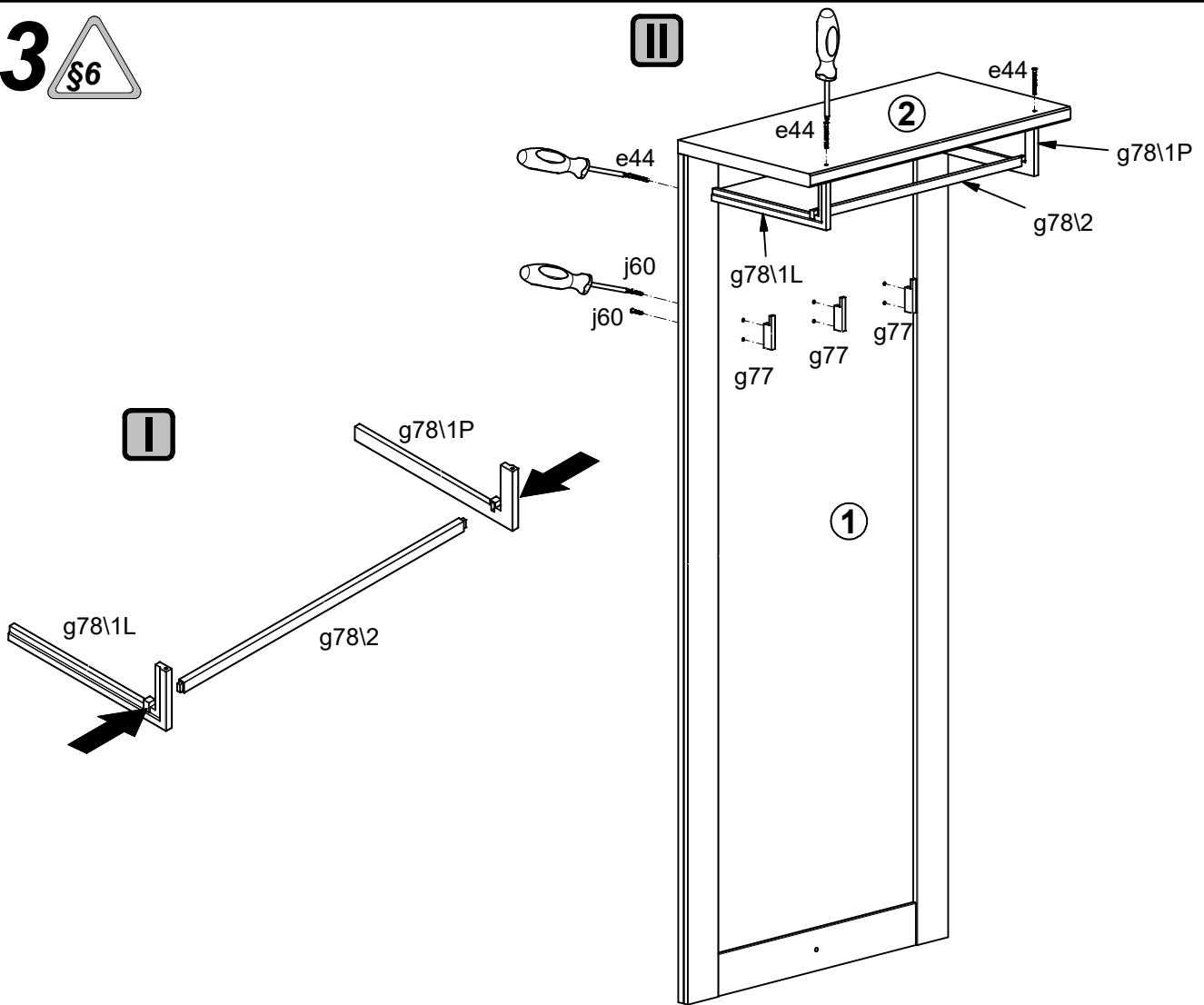

# 4 §6

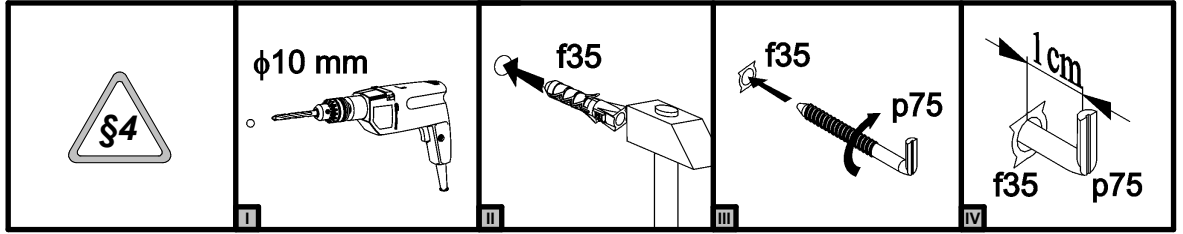

φ10 mm

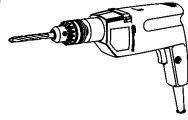

f35

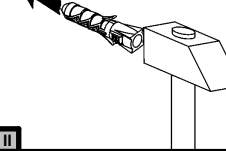

f35

p75

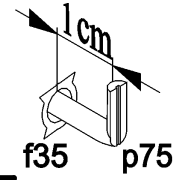

1 cm  
f35 p75

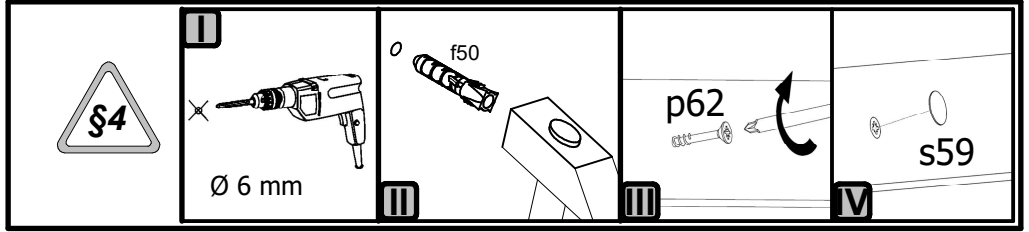
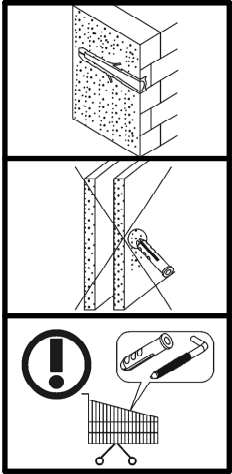

Ø 6 mm

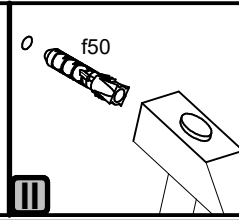
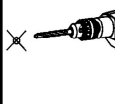

f50

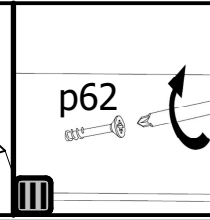

p62

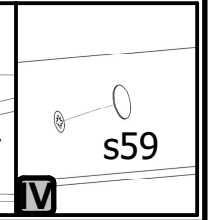

s59

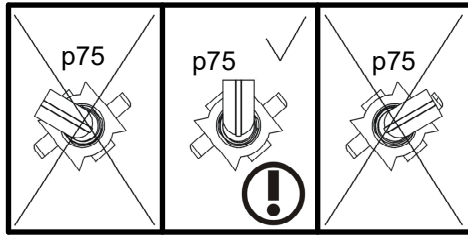

p75

p75

p75

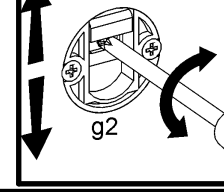
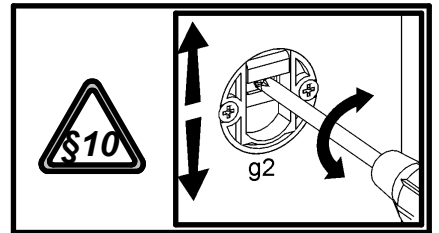

g2

